



Product Manual

4250 Airless™ Striping Machine

10003947



Proudly Made in the USA
Newstripe.com • 303-364-7786

4250 Airless™ Striping Machine

TABLE OF CONTENTS

Precautionary Warnings.....Page 1

Assembly.....Page 2

Operation.....Page 3

Spray Tip Cleaning.....Page 4

Cleaning Procedure.....Page 4

Cleaning Procedure..... Page 5
(Extended Periods)

Cleaning Procedure.....Page 5
(Winter Storage)

Maintenance.....Page 5

Parts ListPage 6

Engine Lubricant & PartsPage 6

Airless Pump PartsPage 7

Airless Pump DetailPage 7

Airless Spray Gun DetailPage 8

Troubleshooting Guide.....Page 9

Warranty.....Page 10

Thank you for purchasing the Newstripe 4250 Airless™ Striping Machine.

Please read over the instructions and make sure you understand the operating procedures before using the unit.

Please check the serial number on your unit. This Manual is for units with serial number 10336537 and above only. For units with serial numbers below 1036537, please contact Newstripe for the correct manual.



4250 Airless™ Striping Machine



PRECAUTIONARY WARNINGS

- **PLEASE** read and understand all operation instructions as detailed in this manual. Failure to follow specified instructions may result in equipment damage or severe injury to personnel.
- **CAUTION:** High pressure spray can inject toxins into blood stream. **If injection occurs, seek emergency medical treatment.** Keep away from high pressure spray.
- **CAUTION:** Never point or discharge gun toward anyone or any part of your body. Gloves and other forms of clothing will not provide protection against injection injury.
- **WARNING:** Never try to stop leaks with any part of your body.
- **WARNING:** Never spray without a tip guard in place on the spray gun.
- **ALWAYS** engage the trigger lock when not spraying and make sure it is functioning properly.
- **WARNING:** Never leave the machine unattended with the system pressurized. When not spraying, always relieve the pressure in the system by turning the prime/spray valve knob on the pump to the recirculate position. 
- **CAUTION:** This system is capable of producing 3000 psi. Use only Newstripe Airless replacement parts rated at 3000 psi or higher.
- **DO NOT** remove the spray tip from the gun while cleaning the pump, or while the system is under pressure.
- **DO NOT** clean the spray tip in the spray gun. Relieve the pressure on the system and then remove the spray tip for cleaning.
- **ALWAYS** relieve the pressure in the system and remove the spray tip from the spray gun before cleaning the tip guard.
- **ALWAYS** consult your Facility Safety and/or Personnel Department for specified safety protocols prior to operating this equipment.
- **NEVER** use solvents containing halogenated hydrocarbons such as methyl bromine, carbon tetrachloride and ethyl iodine.

4250 Airless™ Striping Machine

ASSEMBLY

1. Remove the unit from the crate and open the packing cartons. Check for any damage that may have occurred during shipment. If you see any possible damage, make a note of it on the delivery paperwork and advise Newstripe immediately.
2. Set the handles behind the unit with the gun off to the right side. Attach the bottom of the handles to the back of the chassis with 5/16-18 x 1-1/2" hex head bolts, washers and lock nuts. Hand tighten only at this time.
3. Rotate the handle assembly upward and then rotate each handle brace (connected at the back axle) upward so that the holes in the braces line up with the upper holes in the handle assembly. Attach the top of the braces to the handles with 5/16-18 x 1-1/2" carriage bolts, and lock nuts. Tighten all bolts at this time. (Pic 1)

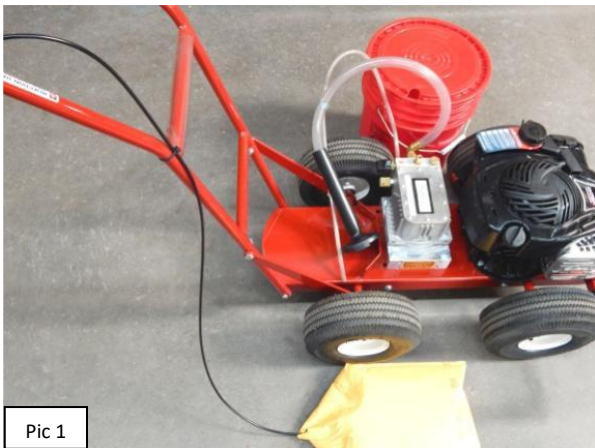

4. Set the pail on chassis. Place the suction and return hoses into the pail and then clip them together with the metal clip inside pail. Insert the hoses into the notches of the lid and then snap lid onto the pail. Check the placement of spray gun in the gun mount.
5. Unpack the spray gun and mounting bracket from the bag attached to the cable on the handle assembly.
6. Loosen the two 5/16" bolts on the front of the chassis and then slide the spray gun support tube outward to the right until the end of it is flush with the left side of the receiver. Snug the two 5/16" bolts to secure it in place.

7. Slide the spray gun mounting bracket (with gun) onto the upright of the support arm and hand tighten the star knob.
8. Check placement of the spray gun in the gun bracket. Spray gun should be located so that there is room between the trigger and lifting bar that lifts trigger (1/8"-3/16"). This will allow the gun to shut off completely when the trigger is released.
9. There should also be enough room to push the trigger lock sideways. If the trigger lock will not push, release the gun clamp and slide gun backward until you can push the trigger lock. Re-clamp gun.

NOTE to release trigger lock: Push the trigger lock in on the right side (outside) of the gun.

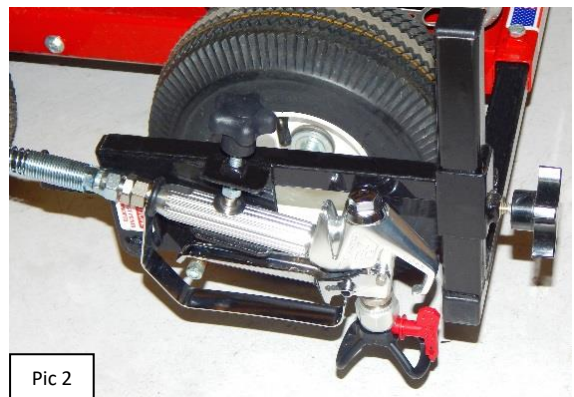

10. Attach one end of the spray hose to the pump outlet with a 3/4" wrench and the other end to the spray gun. You will need two wrenches (3/4" and 11/16" or two adjustable wrenches) to secure the hose on the spray gun. Make sure both connections are tight.
11. **This unit is shipped WITHOUT oil and gas.** Fill the engine with 15 ounces of Full Synthetic SAE 5W30 motor oil. Check the oil level in the engine before starting.
12. Fill the fuel tank with unleaded gasoline (87 or higher octane).
13. Make sure that the static chain is contacting the ground (Attached to the bottom side of the frame).

4250 Airless™ Striping Machine

OPERATION

We recommend practicing with water to learn the controls and machine operation. If you are going to use oil-based paint, you will have to flush out the water with paint thinner or mineral spirits prior to using the oil-based paint. **ALWAYS STRAIN THE PAINT BEFORE USE!**

1. Turn the black Spray Control Knob to the Prime/Re-circulating position (arrows in a circle) in line with the arrow on the side of pump block.
2. The gold knurled Pressure Control Knob should be turned all the way in clockwise to just where it just stops. (**Do not over tighten**)
3. Start the engine. You should see liquid start to flow back to the pail in the return hose. Let this run until there are no air bubbles in the return hose. If the bubbles do not stop, check the tightness of the suction hose fitting at the pump.
4. Turn the Spray Control Knob to the spray position. (Spray gun symbol in line with arrow on side of pump block)
5. Squeeze the spray trigger lever on the handle, and paint will spray from the gun.
6. Adjust the pressure by turning the pressure control knob counterclockwise until the spray pattern decreases, then increase the pressure by turning the knob clockwise just to where you get a good even spray pattern. You should run the system at the lowest pressure possible that still gives you satisfactory results. This will reduce system wear.
7. Adjust the spray gun height for the desired line width.
8. When you finish spraying or if the machine will be left unattended for any amount of time, turn the Spray Control Knob to the Re-circulating Position, turn off engine, and then squeeze the spray trigger lever to release the pressure from the system. **Turn off the fuel supply valve.**

OPERATIONAL NOTES

- **NOTE:** If the pump does not prime, turn off the pump by moving the pump engaging lever to the OFF position, and then back out the pressure control knob several turns (counterclockwise) until it feels loose. Push the outlet button 3 times, and then move the pump engaging lever back to the ON position. Leave the spray control knob in prime/re-circulating position and let the pump run for FIVE MINUTES. After 5 minutes, turn the pressure control knob back in until it stops. The pump should now prime.
- **NOTE:** If the pump primes and air bubbles continue to appear in the hose after one minute, the suction hose fitting may not be tight enough or the rubber washer may be worn. Turn off the machine, turn the spray valve to the prime position, and then squeeze the spray trigger lever to open the gun and release the pressure.
- Disconnect the suction hose from the inlet of the pump, depress inlet valve stem to make sure it is free, and then inspect the hose washer to make sure it is seated and in good condition. Re-attach the suction hose to the pump, making sure that the fitting is hand tight. You may have to snug it additionally with pliers if you continue to get air bubbles in the return hose. Start the engine and repeat the first steps for operation.

QR code link for
bleed procedure video





4250 Airless™ Striping Machine

SPRAY TIP CLEANING DURING USE

1. Place the Spray Control Knob in the re-circulating position, and then squeeze the spray trigger lever to release the pressure from the system.
2. Turn the spray tip arrow on the spray gun so that the arrow points toward the gun.
3. Turn the spray control knob to the spray position and trigger the gun. This should clear the gun. Turn the spray control knob to the prime position and trigger the gun to release the pressure.
4. Reverse the spray tip so that the spray tip arrow points toward the ground.
5. Turn the prime/spray knob to the spray position and resume spraying. If the spray gun continues to clog, check the filter in the gun handle.
6. Turn the prime/spray knob to the prime position.  Turn off the machine. Remove the paint hose from the spray gun.
7. Press the trigger lock on the side of the spray gun to lock the spray trigger. Remove the gun from the gun mount. Push forward on the spray trigger guard to release the guard from the front of the gun.
8. You can now unscrew the handle. The filter pulls straight out of the handle. Only rinse the filter to clean it. If the filter is still clogged, collapsed or dented, replace the filter. Reinstall the filter. If there are still issues, proceed to the cleaning procedure.

CLEANING PROCEDURE

1. Remove the pail with the paint.
2. Place an empty pail on the machine and fill it with 2 gallons of water if using latex paint. If using oil or alkyd paint, use enough of the appropriate solvent that the suction filter is covered.
3. Place the return hose in a waste container and make sure the prime/spray knob is in the prime position. 
4. Start the engine and let it run with the pump in the prime position until the fluid in the return hose runs clear.
5. Turn the prime/spray knob to the spray position and then trigger the gun into the waste container until the spray runs clear.
CAUTION: When using a flammable solvent with a metal pail, touch the metal part of the spray gun to the side of the grounded metal pail to eliminate static discharge between the pail and spray gun. Keep your face clear of the pail.
6. Turn the prime/spray knob to the prime position.  Turn off the machine and then trigger the spray gun to release the system pressure.
7. Wipe down the suction tube and return hose.
8. Clean the spray tip if needed with a nylon bristle brush. **DO NOT** use a metal bristle brush or pick.



PRECAUTIONARY WARNINGS



- **ALWAYS** release the pressure in the system before changing or cleaning the spray tip. (Place the prime spray knob in the prime position , turn off the machine, and then squeeze the spray trigger to release the pressure).
- **NEVER** use fuel such as gasoline to clean the equipment.
- **NEVER** use solvents containing halogenated hydrocarbons such as methyl bromine, carbon tetrachloride and ethyl iodine.

4250 Airless™ Striping Machine

CLEANING PROCEDURE FOR EXTENDED PERIODS OF NON-USE

1. Clean the machine as instructed in the cleaning procedure.
2. Pick up suction filter and hold it with the bottom facing up and then pour about 2 ounces of Pump Defender into the suction filter so there is about 2 inches of fluid showing in the suction hose.
3. Leave the engine off and pull the recoil starter until you see Pump Defender in the return hose.
4. The machine may now be stored with Pump Defender remaining inside the hoses and pump.

CLEANING PROCEDURE FOR WINTER (FREEZING) STORAGE

1. Clean the machine as instructed in the cleaning procedure and then place ½ bottle of Pump Defender in the pail.
2. Place the prime/spray knob in the prime position  and the run pump until Pump Defender flows from the return hose.
3. Turn the prime/spray knob to the spray position and trigger the gun until Pump Defender sprays from the gun.
4. Turn the prime/spray knob back to the prime position , move the pump engaging lever to the OFF position, and then trigger the spray gun to release the pressure.
5. Remove as much fuel from the engine gas tank as you can, and then start the engine and run it until it runs out of gas.
6. Disconnect the paint hose from the pump and gun, and then drain the hose.
7. Reconnect the paint hose to the gun and pump. The machine may now be stored in freezing temperatures.
8. Check the engine oil in the spring after it warms enough to paint. Use SAE 5W-30 Full Synthetic Motor Oil.

MAINTENANCE

ITEM	CHECK	MAINTENANCE ACTION
Engine Oil	Before each use	No oil changes per Briggs & Stratton
Spark Plug & Air Filter	Check monthly	Clean or change as needed.
Wheels	Lubricate weekly	Grease the wheels with bearing grease.
Gun Mount Clamp Star Knob	Lubricate weekly	Lubricate the threads with light machine oil.
Spray Gun Cable and Cable Clamp	Check weekly	Lubricate with a quality dry lubricant.
Spray Gun Filter	Check monthly	Replace if filter becomes clogged.
Spray Pump	Before and after each use	Use Pump Defender if the unit will not be used for more than one day.
Suction Filter	Before each use	Replace as needed or when clogged.
Suction Tube	Before each use	Replace if needed or has cuts.
Bypass (Return) hose	Before each use	Replace if needed or has cuts.
Spray Hoses	Before each use	Replace if needed or has cuts.
Spray Tip	Before each use	Replace if spray pattern is uneven or narrow.
Outlet Push Button	Before each use	Replace every 1000-1500 gallons or if leaking.
Outlet Valve	If pump does not prime	Replace every 500-1000 gallons.
Inlet Valve	If pump does not prime	Replace every 500-1000 gallons.
Prime/Spray Valve	If pump will not toggle between Prime/Spray	Replace every 1000-1500 gallons or if it stops working.

4250 Airless™ Striping Machine

PARTS LIST

Item	Description	Part Number
#1	25' Airless Paint Hose	10000458
#2	Airless Spray Gun with 517 Tip	10005114
#3	Spray Gun Star Knob	10004932
#4	Spray Gun Trigger Lifting Bar	N/A
#5	Spray Gun Support Arm	10003950
#6	Spray Gun Mount Assembly	10003884
#7	Spray Tip Guard w/Base	10005116
#8	Spray Gun Filter (Package of 2)	10000641
#9	517 Reversible Spray Tip (2"-4" Line)	10000508
#10	Hand Grip (2)	10004281
#11	Handle Bars	10003949

Item	Description	Part Number
#12	Handle Braces (2)	10004570
#13	Chassis	10003948
#14	Belt Guard (Not Shown)	10003957
#15	Belt, (AX25)	10003940
#16	Star Knob	10000007
#17	Spray Control Lever	10002951
#18	Spray Control Cable	10002516
#19	Pulley, Engine	10000131
#20	Pulley, Pump Drive	10000708
#21	Wheels, 10" Pneumatic (4)	10000012

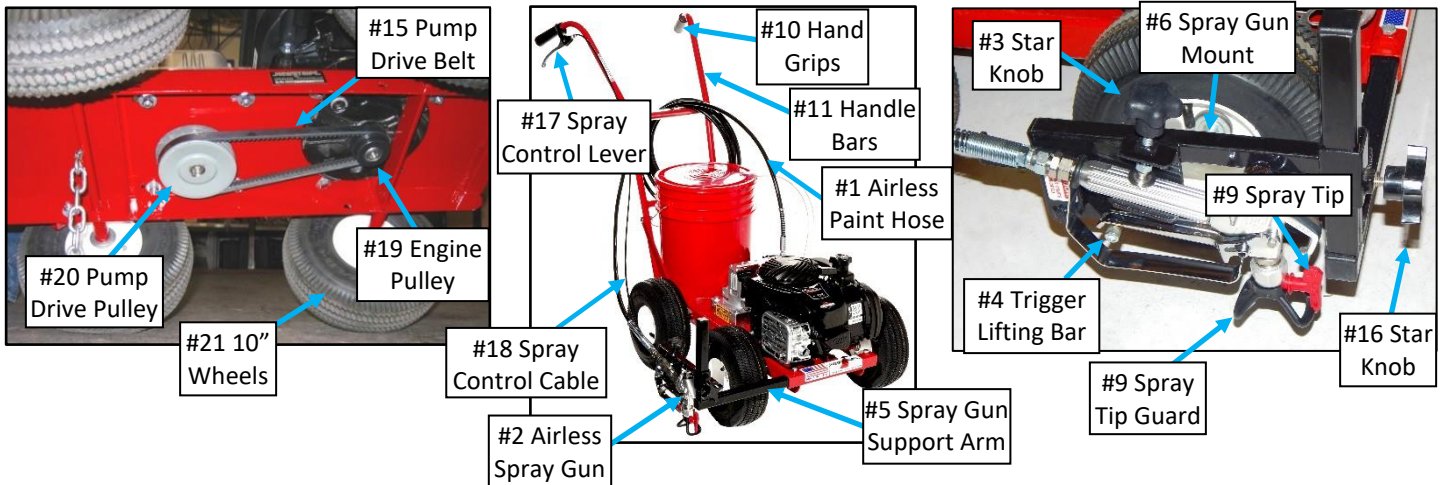

ENGINE LUBRICANT AND PARTS

ITEM	SPECIFICATIONS
Engine	Briggs & Stratton 550EX Series (Part Number 10004608)
Oil Capacity	15 Ounces (0.44 Liters) Full Synthetic SAE 5W-30
Spark Plug	Briggs & Stratton 692051 (550EX Series Engine) Briggs & Stratton 594056 (EXi 725 Series Engine)
Air Filter	Briggs & Stratton Part# 593260 (Part Number 10004969)

4250 Airless™ Striping Machine

AIRLESS PUMP PARTS

Item	Description	Part Number
#22*	Outlet Valve	10005102 (Kit)
#23*	Outlet Valve Push Button	
	*#22 & #23 Available in Kit Only	
#24	Airless Spray Pump	10005236
#25	Prime/Spray Control Valve	10004000
#26	Pressure Control Knob	N/A
#27	Inlet Valve	10002745

Item	Description	Part Number
#28	Suction Hose Filter (Inside Pail)	10001760
#29	Suction Hose Sleeve (Inside Pail)	10003932
#30	Suction Hose	10003959
#31	Bypass Hose (Return)	10003960
#47	Suction Hose Washer (5 Pack)	10000711
#48	5-Gallon Pail Strainer (5 Pack)	10003569
**	Airless Pump Maintenance Kit (Includes #26, #27, #29, #31, & #36)	10004609

AIRLESS PUMP DETAIL

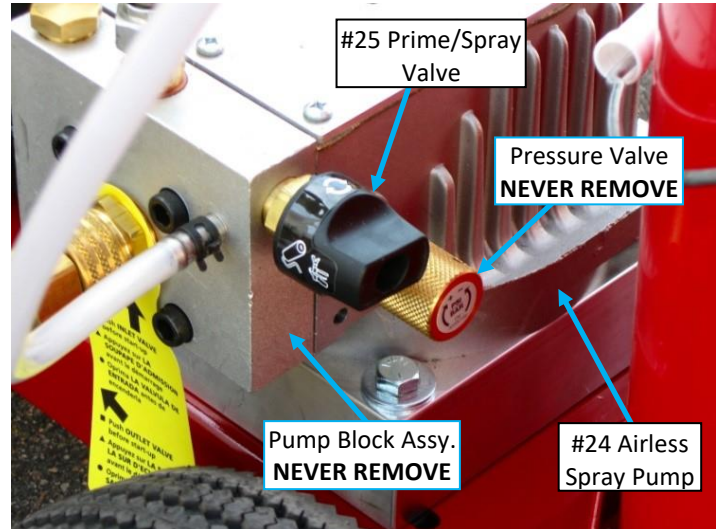
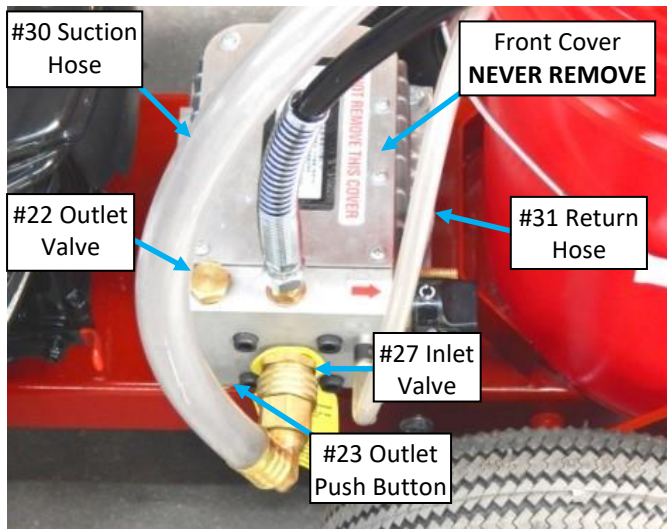

ITEM	CHECK	REPLACE
Spray Tips: 517 2"-4" Width 619 4"-6" Width	Before each use.	Every 75-500 gallons, or when the line quality becomes poor.
Suction Filter 10001760	Before each use.	If the filter becomes clogged.
Gun Filter 10000641	Every 25 gallons or if the gun does not spray.	REPLACE ONLY DO NOT CLEAN (every 50-250 gallons).
*Outlet Push Button 10005102	Before each use.	Every 1000-1500 gallons or if leaking.
*Inlet Valve 10002745	If the pump does not prime. Check the hose washer at the same time.	Every 500-1000 gallons. Washer- Every 50-250 gallons.
*Outlet valve 10005102	If the pump does not prime.	Every 500-1000 gallons.
Prime/Spray Valve 10004000	Only if it stops working.	Every 1000-1500 gallons or if it stops working.
Suction Hose	Before each use check for nicks or cuts.	As needed if damaged or clogged.
Bypass/Return Hose	Before each use check for nicks or cuts.	As needed if damaged or clogged.

*Interval ranges may vary due to the wide variety of paint types.

4250 Airless™ Striping Machine

AIRLESS SPRAY GUN DETAIL

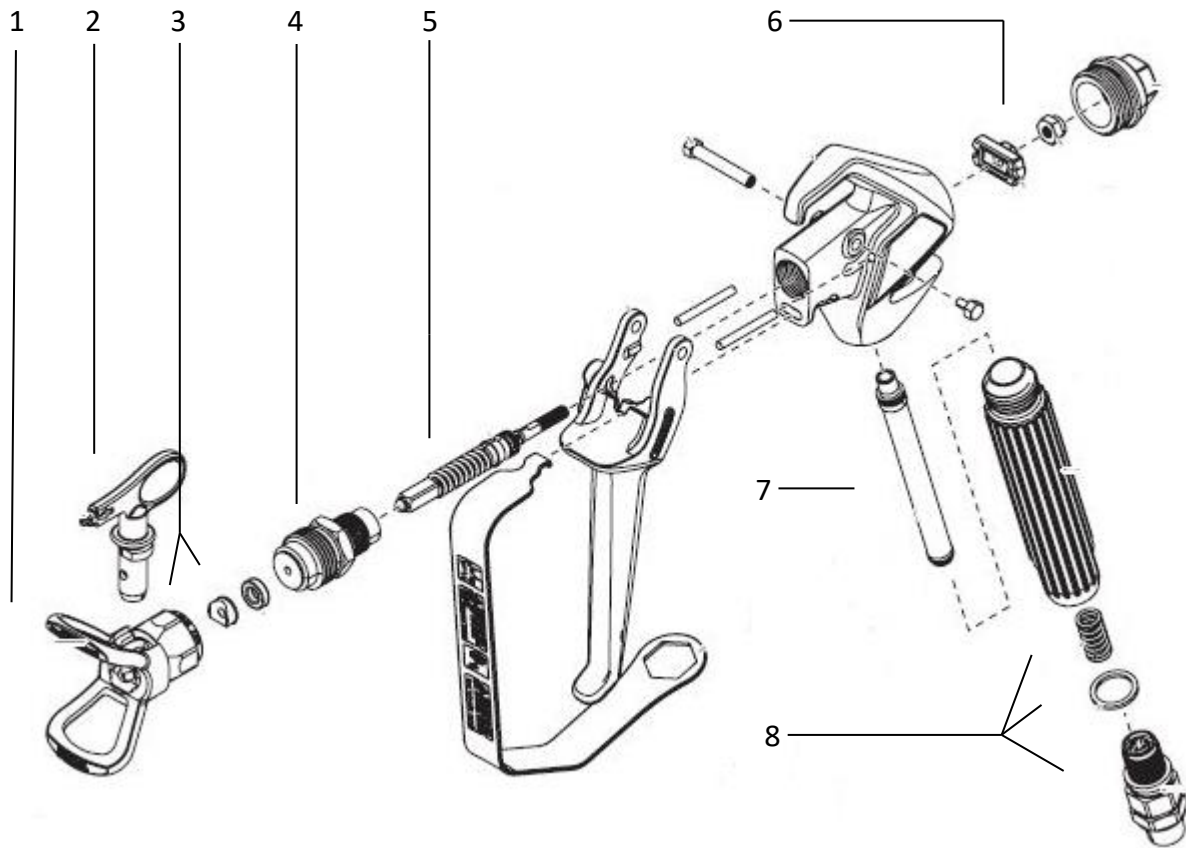

#	Part Number	Description
1	10005116	SPRAY TIP GUARD
2	10002103	319 SPRAY TIP - STANDARD FOR GPS AND SKID MOUNTED STRIPERS
	10000508	517 SPRAY TIP - STANDARD FOR WALK BEHIND STRIPERS
	10004860	519 SPRAY TIP - STANDARD TIP FOR RIDE ON STRIPERS
	10003824	619 SPRAY TIP - ALLOWS FOR WIDER LINES THAN 517 & 519 SPRAY TIPS
3	10005119	TIP SEAL KIT, PACKAGE OF 5
4	SEE # 9	7/8" DIFFUSER
5	SEE # 9	SEAL NEEDLE ASSEMBLY
6	SEE # 9	LOCK NUT
7	10000641	50 MESH GUN FILTER - STANDARD FILTER FOR STRIPERS
	10004384	OPTIONAL 30 MESH COARSE GUN FILTER
8	10005135	SWIVEL FITTING KIT
9	10005117	AIRLESS SPRAY GUN REPAIR KIT (Includes Item Numbers 4, 5, and 6)

4250 Airless™ Striping Machine

TROUBLESHOOTING GUIDE

**NEVER REMOVE THE FRONT COVER, PRESSURE ADJUSTING VALVE OR THE PUMP HEAD BLOCK.
THIS WILL VOID THE WARRANTY. CALL NEWSTRIPES FOR SERVICE LOCATIONS IF THESE ITEMS REQUIRE SERVICE.**

PROBLEM	REMEDY
The engine will not start.	Check that the fuel shutoff and ignition switch are in the on position, the choke lever is in the Choke position and the throttle lever is in the run position. Check that the fuel tank has adequate fresh fuel. Call Newstripe for assistance.
The engine starts but runs rough.	Check that the choke lever is in the off position.
The choke lever is in the off position, but the engine still runs rough.	Check for proper fresh fuel. Check the spark plug for fouling. Clean or replace the spark plug if needed. Check air filter to make sure it is not dirty or clogged.
The drive lever is engaged, but the machine will not move.	Drive rollers not contacting tire or contacting too lightly. Check tire pressure. Adjust rod until rollers contact wheels firmly. Call Newstripe for assistance.
The drive rollers are contacting the tires but are slipping.	Check to make sure the tire pressure is correct (30 psi Max). Adjust the drive rod if necessary. Replace the drive rollers if they are worn.
The pump will not prime. (No fluid returning to pail)	Check that Prime/Spray control knob is in the Prime position (Circular arrows aligned with the arrow on the pump block). Push the brass outlet valve button 3 times and ensure that the pressure adjustment valve is turned in fully clockwise.
The outlet valve button has been pushed, and the pressure valve is turned in fully clockwise, but the pump will still not prime.	Turn off the pump, and then turn the pressure control knob out (counterclockwise) several turns until it turns freely. Turn on the pump and run it for 5 minutes. Turn pressure control knob slowly all the way back in. You should start seeing flow in the return hose. The pump should now prime. If you still have no flow, please call Newstripe for assistance.
Fluid is returning to the pail in the bypass/return hose, but air bubbles are still present in the hose after 60 seconds.	Check the inlet hose fitting for tightness, or a worn or missing rubber washer. Check suction the hose for nicks or cuts that would allow air into the system. Call Newstripe for assistance if needed.
The pump primes, but the gun will not spray.	Check that the Prime/Spray control knob is in spray position. Check that the pressure control knob is turned in fully clockwise to high pressure, until it stops. Do Not Force. Check to ensure that the suction filter is below fluid level. Press the brass outlet valve button three times. Make sure that the spray tip is not obstructed.
All knobs are set correctly on the pump, but the gun still does not spray.	Check that the trigger lock on the spray gun is turned to the spray position (wings parallel to gun body). Check that the spray tip arrow is pointing toward the ground. Check that the gun trigger handle is operating the spray gun.
All of above are correct, but the gun will still not spray.	Turn the Prime/Spray control knob to the prime position, turn off the engine, and pull the spray gun trigger to release the pressure in the system. Check the spray gun filter and replace it if it is plugged. Call Newstripe for assistance if needed.
Overspray or too much paint.	Lower the spray pressure by turning spray pressure control knob counterclockwise several turns, and then increase the pressure until you obtain a good spray pattern.
Too little paint.	Increase the spray pressure until you obtain a good spray pattern. The paint may need to be thinned some in cooler temperatures or if the paint viscosity is very thick.
Uneven spray pattern or stringing.	Increase the spray pressure. The spray tip may be chipped or clogged. Reverse the tip to clear any obstruction and clean it if necessary.
The pressure has been increased, and tip is clean, but the spray is still not correct.	You most likely have a worn spray tip. Replace the spray tip. Call Newstripe for assistance if needed.

Your machine is designed to be simple and safe to operate.

Please call us at 303-364-7786 if you have any questions during setup, painting or cleaning.

4250 Airless™ Striping Machine

10003947

24 Month Warranty

Newstripe, Inc. ("Newstripe") warrants to the original purchaser, for 24 (Twenty Four) Months after date of purchase, that the equipment* hereby sold shall be free of defects in materials and workmanship. This warranty does not extend to any damage or malfunction resulting in misuse, neglect, accident, improper operation, or normal wear and tear.

* Gasoline engines, compressors, low pressure pumps, and transaxles are furnished with their respective manufacturers' warranties only and are not covered by any warranty of Newstripe. High pressure pumps manufactured by Newstripe (excluding wear items like diaphragms and valves) are warranted for materials and workmanship for 12 Months after the date of purchase.

Damage incurred in shipment from Newstripe to the purchaser is the total responsibility of the shipping carrier. The purchaser is responsible for noting any damages on the Bill of Lading of the shipping carrier and Newstripe will work with the shipping carrier to resolve any damages incurred.

The Newstripe obligation under this warranty and any implied warranties is limited to replacement or repair of defective parts of its manufacture without charge for 24 (Twenty Four) Months from date of purchase. For service under this warranty, the purchaser shall obtain an approved Return Materials Authorization (RMA) from Newstripe and then ship the defective part or parts of the equipment, transportation prepaid by the purchaser, to Newstripe together with a written description of any claimed defect and proof of purchase date of the materials being returned. To review Newstripe's complete guidelines for warranty claims and returns, please visit our website at www.newstripe.com.

The responsibilities described above are the only responsibilities of Newstripe under this written warranty or any implied warranty and may be exercised only within 24 (Twenty Four) Months from the date of original purchase. In no event shall Newstripe be liable for incidental or consequential damages and no person had any authority to bind it to any representation or warranty. Newstripe is not responsible for work done, materials furnished, or repairs made by others without its specific written authorization.

This warranty shall be in lieu of any and all other warranties, expressed or implied, including any warranties of merchantability or fitness for a particular purpose, and there is no other representation or warranty of any kind with respect to the goods sold hereby except as set forth herein. It is expressly agreed that this warranty shall be limited to the adjustment, repair or replacement of parts and the labor and services required thereby. In no event, including any claim of negligence, shall Newstripe be liable for incidental or consequential damages.



Newstripe.com / 303-364-7786