



## Product Manual

# NewRider™ 1700 Airless Riding Field Line Striper

10004026



**NOT FOR SALE IN CALIFORNIA**

Proudly Made in the USA  
newstripe.com • 303-364-7786

# NewRider™ 1700 Airless Riding Field Line Striper

## TABLE OF CONTENTS

Precautionary Warnings .....	Page 1
Assembly .....	Page 2
Operation .....	Page 3-6
Spray Tip Cleaning .....	Page 7
Cleaning Procedure.....	Page 7
Cleaning Procedure..... (Extended Periods or Winter Storage)	Page 8
Maintenance .....	Page 9
Parts List .....	Page 10-11
Detailed Parts Pictures.....	Page 11-13
Airless Pump Detail.....	Page 14
Airless Spray Gun Detail.....	Page 15
Transaxle Service .....	Page 16-17
Troubleshooting Guide .....	Page 18-19
U.S EPA and Newstripe Inc. Evaporative Emission Control Warranty Statement .....	Page 20-21
Warranty .....	Page 22

**Thank you for purchasing the Newstripe  
NewRider™ 1700 Riding Field Line Striper.**

Please read over the instructions and make sure you understand operating procedures before using the unit.

Please check the serial number on your unit. This Manual is for units with serial number 1042182 and above only. For units with serial numbers below 1042182, please contact Newstripe for the correct manual.



# NewRider™ 1700 Airless Riding Field Line Striper



## PRECAUTIONARY WARNINGS

- **PLEASE** read and understand all operation instructions as detailed in this manual. Failure to follow specified instructions may result in equipment damage or severe injury to personnel, up to and including death.
- **CAUTION:** High pressure spray can inject toxins into blood stream. **If an injection occurs, seek emergency medical treatment.** Keep away from high pressure spray.
- **CAUTION:** Never point or discharge the gun toward anyone or any part of your body. Gloves and other forms of clothing will not provide protection against injection injury.
- **WARNING:** Never try to stop leaks with any part of your body.
- **WARNING:** Never spray without a tip guard in place on the spray gun.
- **ALWAYS** engage the trigger lock when not spraying, and make sure it is functioning properly.
- **WARNING:** Never leave the machine unattended with the system pressurized. When not spraying, always relieve the pressure on the system by turning the prime/spray valve knob on the pump to the recirculate position. 
- **CAUTION:** This system is capable of producing 3000 psi. Use only Newstripe Airless replacement parts rated at 3000 psi or higher.
- **DO NOT** remove the spray tip from the gun while cleaning the pump, or while the system is under pressure.
- **DO NOT** clean the spray tip in the spray gun. Relieve the pressure on the system and then remove the spray tip for cleaning.
- **ALWAYS** relieve the pressure on the system and remove the spray tip from the spray gun before cleaning the tip guard.
- **ALWAYS** consult your Facility Safety and/or Personnel Department for specified safety protocols prior to operating this equipment.
- **NEVER** use solvents containing halogenated hydrocarbons such as methyl bromine, carbon tetrachloride, and ethyl iodine.

# NewRider™ 1700 Airless Riding Field Line Striper

## ASSEMBLY

1. Check for any damage that may have occurred during shipment. Advise the factory immediately if you see any damage. Remove the unit from the crate by removing the top boards, then the boards at the ends of the crate. Remove the tie down straps and then remove any shipping cartons.
2. Access the transaxle release lever at the rear of the machine. Pull the lever up, push in and then down to disengage. (Picture 1)



3. Release parking brake if applied. You should be able to roll the machine out of the crate by pushing on the rear bumper. DO NOT STAND IN FRONT OF THE MACHINE WHILE ROLLING OUT OF CRATE.
4. Mount the spray head support by aligning the two holes in the bumper bracket with the two holes in the frame. Insert two 1/2"x3" bolts in the holes from the front. Place one washer and one nylock nut on each bolt and tighten.
5. Cut the tie that secures the lift lever lock spring to the machine. Hook the bottom of the spring into the loop in the bottom of the mounting bracket.
6. Press on foot release for the spray head (lever on the left side of the steering column) to lower the spray head support tube.
7. Mount the spray head caster assembly by sliding the caster arm onto the spray head support tube and tighten bolts. The caster wheel may be adjusted to the left or right so that the rear wheels will clear the striped line when turning. (Picture 2)
8. Slide the spray gun mounting bracket over the upright on spray head support tube and tighten bolt. Adjusting the spray gun mounting bracket up or down will adjust the spray width. (Picture 3)

9. Place the spray gun in the holder without the hose attached and secure with the clamp. (Picture 4)
10. The spray gun may have to be moved forward or backward in the clamp so that there is approximately 1/8" of space between the trigger and the lifting bar. This should also leave enough room to push the trigger lock sideways. (Picture 4)
11. If the trigger lock will not push release the gun clamp and slide the gun forward or backward until you can push the trigger lock. Re-clamp gun.

**NOTE:** To release trigger lock, push the lock in on the right side (inside) of the gun.

12. Attach one end of the spray hose to the pump outlet with a 3/4" wrench and the other end to the spray gun. To secure the hose on the spray gun you will need a 3/4" and a 9/16" wrench as it has a swivel fitting.
13. Loop the additional hose over the hanger on the left side of the spray tank. Make sure the hose does not contact the tire. Route the hose through the snap link and around the post at corner of left fender.
14. Always check the oil level in the engine before starting. (SAE 5W-30 Full Synthetic)
15. Make sure the static chain is contacting the ground.

**NOTE:** The NewRider 1700 is Equipped with an EPA/Carb approved recovery system and tethered fuel cap. DO NOT SERVICE OR REMOVE THE VAPOR CANISTER OR TETHERED FUEL CAP FROM THE MACHINE. DO NOT REPLACE ANY FUEL SYSTEM PARTS WITH NON-APPROVED PARTS.

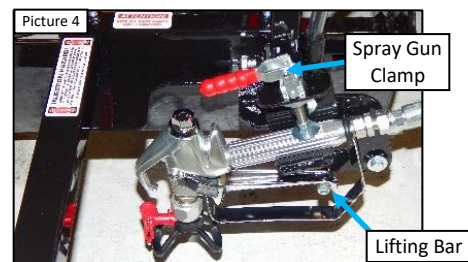
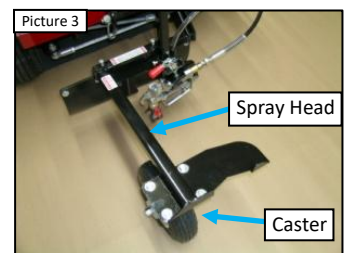
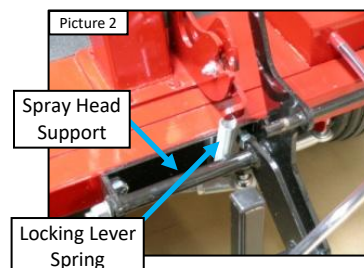

# NewRider™ 1700 Airless Riding Field Line Striper

## HOUR METER & TACHOMETER OPERATION

### TO SET THE TACHOMETER (SPARK PLUG FIRING REVOLUTION)

Press and hold the **S1** button for 4 seconds. The LCD will display **01** (spark plug fires twice per revolution), **02** (once per revolution), **03** (every other revolution), **04** (hours only, will not display RPM). Once you find your desired spark plug firing pattern, release the **S1** button. The LCD will blink for 8 to 10 seconds and return to total hour meter mode. The default for the standard model is **02** (once per revolution). This default can be changed during manufacturing.

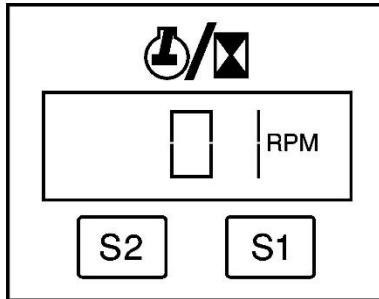

### TO SET THE MAINTENANCE INTERVAL TIMER

Press and hold down the **S2** button for 4 seconds. The right most digit on the LCD will flash and the **SERVICE** icon will be displayed. Pressing and holding the **S1** button will cause the flashing digit to automatically increment. When the desired number has been reached release the **S1** button and press the **S2** button for 1 second to increment to the next digit. Repeat the above steps until the service time interval has been entered. After 14 to 16 seconds with no buttons pressed, the LCD display will return to total hours mode.

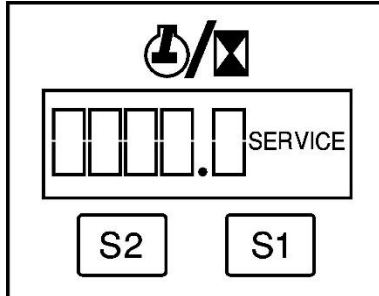

### ACTIVATING THE MAINTENANCE INTERVAL TIMER

Press and hold the **S1** and **S2** button simultaneously for 4 seconds. The two digits will increment to 20 seconds and then return to total hours mode. When the engine is running and the maintenance time has reached zero, the service icon will come on.

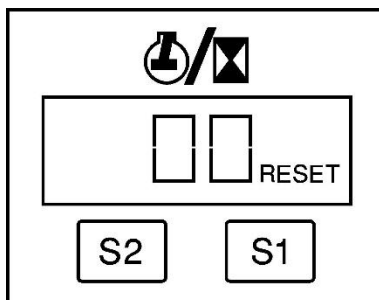

# NewRider™ 1700 Airless Riding Field Line Striper

## VIEWING MAINTENANCE INTERVAL

Press and hold the **S2** button for 4 seconds to view the remaining time of your maintenance interval. To continue current maintenance, do nothing. If you would like to start a new maintenance interval, repeat steps 4 & 5 again. Each time you want to view the remaining time of your maintenance, press, and hold **S2**.

## RESETTING THE SERVICE ICON

Press and hold the **S1** and **S2** buttons for 20 seconds. The service icon will shut off. The maintenance time will automatically default to the number previously programmed.

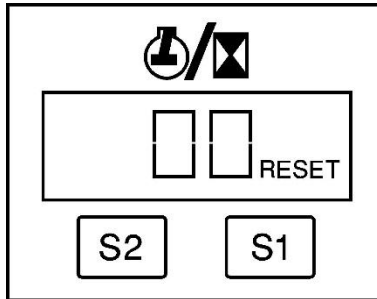

## TO DISPLAY HOURS ONLY

Press and hold the **S1** button until **04** is displayed. Release the **S1** button and the display returns to total hours after 8 to 10 seconds. When the engine is running the display will show hours only, no RPM and the Hour Icon will blink.

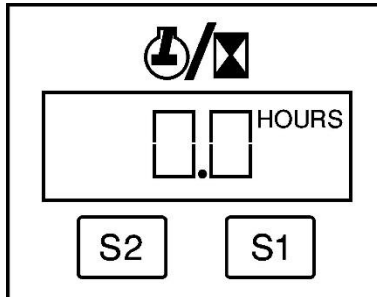

## TO RESET TOTAL HOURS AND MAINTENANCE TIME

Press and hold the **S1** button until **05** is displayed. Release the **S1** button and after 8 seconds the display will return to total hours. Press and hold **S1** and **S2** simultaneously for 20 seconds and the meter will perform a total reset. The total reset option can be removed during manufacture.

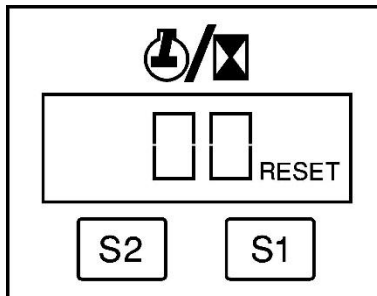

## DRIVING OPERATIONS

# NewRider™ 1700 Airless Riding Field Line Striper

## DRIVING & TRANSPORTATION

1. Before starting, set the parking brake with the hand lever near the seat.
2. Place throttle lever in the choke (Full Forward) position. This will set the choke.
3. Start the engine, when warmed up, move the throttle to  $\frac{3}{4}$  open. (where engine runs smoothly) Engine does not need to run at full speed to run the spray pump.
4. To move forward, release the parking brake and press the top of the right-hand foot pedal.
5. Pushing the base of the pedal will move the machine in reverse.
6. To stop, release foot pedal.

**NOTE:** If the machine does not move set the parking brake and move to the rear of the machine. Pull the Transaxle release lever up and back to lock into slot. Enter the machine and release the parking brake. It should now move.

7. To travel long distances when not spraying, or to load the machine onto a trailer, lift the spray head using the lift lever on the left-hand side of the steering column. The spray head will lock in position when fully lifted. This also locks the spray gun so that it may not be activated when the spray head is lifted.
8. When loading on a trailer approach the ramp slowly to assure the gun will clear the ramp. You may have to raise the gun or possibly remove it if the ramp is too steep.

## SPRAY OPERATIONS

**First time use or after extended periods of not using the machine use water to test operations and settings.**

**The NewRider 1700 is designed to be used with water based athletic field marking paints.**

**ALWAYS STRAIN THE PAINT BEFORE USE!**

1. Add 5-25 gallons of water or paint to the spray tank and 1-2 gallons of water to the purge tank
2. Push the outlet button 3 times to ensure the outlet valve is moving. The push button is located on the left back side of the pump opposite the spray hose.
3. Turn the pressure control valve to high pressure (fully clockwise). **DO NOT OVER TIGHTEN.**
4. Turn prime/spray valve to prime position. (Circular arrow symbol in-line with arrow on the side of the pump.)
5. Ensure the spray gun trigger lock is disengaged.
6. Ensure the spray gun tip is in the spray position. (The arrow on the spray tip points toward the ground.)
7. Check that the tank feed valve (located under the left side of the tank by the white filter housing) is in the open position (handle in-line with hoses) and the purge feed valve is in the closed position (handle crosswise to hose).
8. Start engine as indicated in steps 1-3 in Driving Operations.
9. Engage the pump by moving the engaging lever to the "On" position. Lift and place in upper notch.

10. With the prime/spray valve in the prime position, fluid should flow through the bypass hose into the paint tank.
11. Let the pump run in the prime position for one minute or until air bubbles are not seen from the bypass hose.
12. Turn prime/spray valve to the spray position. (Spray gun symbol in line with the arrow on the side of the pump housing.)  
**NOTE:** A knocking sound should be present at the pump, indicating the pump is reaching its hydraulic relief pressure.
13. Activate foot pedal trigger and paint will spray from the gun. Releasing pedal will stop spray.
14. Adjust the pressure by turning the pressure valve counterclockwise until the spray pattern decreases, then increase pressure by turning clockwise just to where you get a good even spray pattern. Operating the pump at the lowest pressure while still producing a quality line can increase the life of the pump.
15. Adjust spray gun height for the proper line width.
16. **When finished spraying or if machine will be left unattended for any amount of time, turn the prime/spray valve to prime position, and pull spray trigger to release pressure from the system.**

# NewRider™ 1700 Airless Riding Field Line Striper

QR code link for  
bleed procedure video



## OPERATIONAL NOTES

- NOTE: If the pump primes and air bubbles continue to appear in the hose after one minute, the suction hose fitting may not be tight enough or the rubber washer may be worn. Turn off the machine, turn the spray valve to the prime position, and pull the spray gun trigger to open the gun and release the pressure.
- Remove the garden hose fitting at the inlet side of the pump, depress the inlet valve stem to make sure it is free, inspect the rubber washer to make sure it is seated and in good condition. Re-attach the garden hose fitting making sure that it is tight. You may have to lightly snug it with pliers if you continue to get air bubbles. Start the engine and repeat the first steps for operation.
- If the pump will still not prime, back out the pressure control valve knob until it is loose (several turns). Then turn the prime/spray valve to the prime/re-circulate position. Push the Outlet Prime Button three (3) times (Button is located at the lower left corner of pump near the bottom.) Let the pump run for one minute and then turn in the pressure control valve gold knob (clockwise) just until it stops. The pump should now prime. If the pump will still not prime, please call Newstripe.



# NewRider™ 1700 Airless Riding Field Line Striper

## SPRAY TIP CLEANING DURING USE

1. Place the prime/spray valve in the prime position and press spray trigger pedal to release the pressure.
2. Turn the spray gun tip to the clean position. (The spray tip arrow pointed toward the gun.)
3. Turn the prime/spray valve to the spray position and trigger gun. This should clear the spray gun of blockages. Turn the prime/spray valve to the prime position and trigger gun to release pressure.
4. Reverse the spray gun tip so that the spray tip is in spray mode (spray tip arrow pointed at the ground).
5. Turn the prime/spray valve to spray and resume spraying.
6. If the spray tip appears to be clean and the gun will not spray properly, check the spray gun filter located in the spray gun handle. The filter can be cleaned with soap and water. If the filter is too clogged or dirty to clean it must be replaced.
7. If the spray gun is still clogged, proceed to cleaning procedures below.

## CLEANING PROCEDURE

1. The NewRider™ 1700 is equipped with an on-board purge tank that holds up to 2.5 gallons of water. Make sure this has 1-2 gallons of water.
2. Check that the ball valve on the bottom of the purge tank is in the open position (valve handle in line with hose).
3. Turn the paint tank feed selector valve (located below the tank on the left side) to the closed position (handle crosswise to hose).
4. Turn purge feed valve to open position (handle in line with fittings).
5. Turn prime/spray valve to the prime position.
6. Start engine and move the pump engaging lever to the "On" position (lift and place in upper notch) watch until fluid returning to the tank runs clear
7. Turn the prime/spray valve to the spray position and trigger gun until spray runs clear
8. Clean spray tip if needed with a nylon bristle brush  
**DO NOT** use brushes with metal bristles or any metal object to clean the spray tip of dried paint. Replace the tip if it cannot be cleaned.
9. If the spray tip appears to be clean and the gun will still not spray, check the spray gun filter located in the handle of the spray gun. If filter cannot be cleaned it must be replaced.
10. Drain paint tank of any unused paint. You may now rinse the inside of the paint tank.  
**NOTE:** You may want to place the machine on a slight incline, so the drain outlet of the tank is at the lowest point.
11. With most of the water drained from the purge tank, (leave about 1" depth) add approximately 4 ounces (1/2 cup) of *Pump Defender* into the purge tank.
12. Start engine, leave prime/spray valve in prime position and pump engaging lever in the "On" position. Watch until you see *Pump Defender* appear from the return hose.
13. Move the pump engaging lever to "Off" and turn off machine. Press spray gun trigger to relieve any pressure.
14. Check the in-line pump filter once each week. (White plastic filter at bottom of tank near tank selector valve). Turn the purge tank feed selector valve to "Off" position. Unscrew the bottom half of filter.
15. Clean the filter bowl and screen and then re-install them.  
**NOTE:** There is a gasket between the lower half of filter housing and the upper portion. Check that this is in place when installing the bottom half of the filter. **Hand Tighten Only.**

# NewRider™ 1700 Airless Riding Field Line Striper

## CLEANING FOR EXTENDED PERIODS OF NON-USE OR IN FREEZING CONDITIONS

1. Clean as indicated in the Cleaning Procedures and drain the purge tank completely of water.
2. Add 8 ounces (1/4 bottle) of Newstripe Pump Defender (10000459) to the purge tank.
3. Start the engine and then place the pump engagement lever to the "On" position. Place the prime/spray valve in the prime position and operate the pump until you see the Pump Defender fluid appear in the bypass hose.
4. Place the prime/spray valve in the spray position and trigger the spray gun until you see Pump Defender fluid spray from the gun. Once liquid starts spraying from the gun quickly release the trigger.
5. Return the prime/spray valve to the prime position and place the pump engagement lever to the "Off" position.
6. Trigger the spray gun to release any pressure from the system.
7. Remove as much fuel from the engine gas tank as possible or add fuel stabilizer.
8. Close fuel shut off and run engine until it runs out of gas.
9. The machine may now be stored in freezing temperatures.
10. Drain and change engine oil in the spring.



### **PRECAUTIONARY WARNINGS**

- **ALWAYS** release pressure in the system before changing or cleaning the spray tip. (Place the prime/spray valve in the prime/re-circulating position, turn off sprayer and squeeze spray trigger to release pressure)
- **NEVER** use fuels to clean the equipment
- **DO NOT** use solvents containing halogenated hydrocarbons such as methyl bromine, carbon tetrachloride, and ethyl iodine.
- **DO NOT** attempt to clean a clogged gun filter. You must replace it.
- **DO NOT** use brushes with metal bristles or any metal object to clean the spray tip of dried paint. Replace the tip if it cannot be cleaned.

# NewRider™ 1700 Airless Riding Field Line Striper

## MAINTENANCE

ITEM	CHECK	MAINTENANCE ACTION
Engine Oil Full Synthetic 5W-30	Before each use	Change the oil after the first 20 hours of operation and then every 100 hours.
Bypass/Return Hose	Before each use	Replace if nicked or has cuts
Spark Plug	Every 4 Months	Clean or change as needed
All Pivot Points	Before each use	Lubricate with light spray oil
In-Line Filter	Before each use	Clean after each use
Spray Gun Filter	Every 25 gallons If gun does not spray	REPLACE ONLY DO NOT CLEAN every 50-250 gallons or if it becomes clogged.
Spray Gun Clamp & Cable	Check weekly	Lubricate with light spray oil
Spray Tip	Before each use	Replace if spray pattern becomes uneven or if tip becomes worn.
Front Axle Steering Knuckle	Lubricate weekly	Lubricate with high quality bearing grease
Wheels	Lubricate weekly	Check air pressure in tires. Lubricate front wheels with high quality bearing grease.
Pump Engaging Lever	Lubricate weekly	Lubricate with light spray oil
Battery	Check monthly	The 12V 18Ah AGM battery is maintenance free and only needs replaced when bad. Charge it if needed.
Air Filter	Check monthly	Change when dirty.
Transaxle Filter	Every 12 months	Change transaxle oil and filter the first 75-100 hours then every 400 hours
Transaxle oil <b>Warning: Use ONLY Newstripe Filter 10003778. Failure to use this filter will void the warranty.</b>	Check if performance is low or if the transaxle is noisy.	Open oil level check port, if no oil runs out, top off with <b>Mobil 1 Full Synthetic 15W50 Motor Oil ONLY. Failure to use the correct oil type and viscosity will cause damage to the transaxle and void the warranty.</b>
General Cleaning	As needed	DO NOT use high pressure power washers. DO NOT use solvents. Use soap and water only.

## ENGINE LUBRICANT AND PARTS

ITEM	SPECIFICATIONS
Engine	Briggs & Stratton 11.5 HP Intek, Part Number 10004999
Oil Capacity	42-44oz Full Synthetic 5W30
Spark Plug	Part number 10004217
Air Filter	Part number 10004216

# NewRider™ 1700 Airless Riding Field Line Striper

## PARTS LIST

Item Number	Description	Part Number
1	12V 18Ah AGM Battery, 6-7/8" L X 3-7/16" W X 6-1/8" H	10003163
2	Transaxle Release/Engage Lever	10004101
3	Parking Brake Lever	10001817
4	Spring, (Seat Lift)	10001756
5	Empty Seat Safety Switch	10002437
Not Shown	Neutral Switch (Under Right Front Fender on Shift Linkage)	10002913
Not Shown	Brake Safety Switch (Under Right Side Seat Console)	10002437
6	Seat Pins, (2 Required)	10003214
7	Engine Throttle Cable	10002484
8	Ignition Switch	10004007
9	Air Filter Housing	N/A
10	Purge Tank Shut Off Valve	10004112
11	Purge Tank	10003198
12	Spray Head	10003746
13	Swivel Caster	10001434
14	Spray Control Cable	10002521
15	25' Airless Paint Hose	10000458
16	Airless Spray Gun with 619 Spray Tip	10005115
Not shown	Spray Gun Filter (2 Pack)	10000641
17	Spray Gun Clamp Assembly	10005152
18	Gun Mount Assembly	10005137
19	Lifting Bar, Spray Gun Trigger (Part of Gun Mount)	N/A
20	Spray Trigger (Part of Spray Gun)	N/A
21	Trigger Lock (Part of Spray Gun)	N/A
22	Spray Tip Guard	10003936
23a	619 White Spray Tip, 4"-8" line width (standard)	10005151
23b	419 White Spray Tip, Up to 4" line width	10005230
24	Height Adjustment Bolt	10001499
25	25 Gallon Tank	10004005
26	Tank Drain Valve	10002366
27	Bulkhead Fitting, Tank Drain	10000921
28	½" Ball Valve (Common)	10004110
29	In-Line Filter	10000369
Not Shown	Replacement Screen, Inline Filter	10000100
Not Shown	O-ring Bowl Gasket, Inline Filter	10001543
30	Motion Pedal, Forward/Reverse	10004087
31	Spray Control Pedal	10004819
32	Spray Head Support	10003751
33	Spray Head Latch	10003725
34	Pump Engaging Lever	10004066
35	Purge Feed Hose	10004039
Not shown	Purge Outlet Hose (Purge Tank to Shut Off)	10004038
36	Lift Lever Lock Spring	10000692
37	Tank Outlet Hose	10004041
38	Belt, Drive (AX39)	10001218
39	Pulley, Drive Belt & Pump Belt Idler (2)	10003815

# NewRider™ 1700 Airless Riding Field Line Striper

## PARTS LIST CONTINUED

Item Number	Description	Part Number
40	Spring, Drive Tensioner	10002897
41	Belt, Pump Drive (Kevlar 4L360)	10004008
42	Pulley, Pump Drive	10003819
43	Pulley, Pump	10003053
44	Spring, Pump Idler (Not Shown)	10004017
45	Pulley, Drive	10004010
46	Pulley & Fan Assembly, Transaxle	10003062
47	Filter, Transaxle Oil	10003778
48	Parking Brake, Transaxle	N/A
49	Parking Brake Linkage	10004081
50	Tie Rod	10004034
51	Steering Wheel	10003241
52	Seat	10003302
53	Drag Link	10004035
54	Engine 11.5 HP Briggs & Stratton Intek	10004999
55	Hour Meter	10002241
56	Front Wheel & Tire Assembly (Not Shown)	10002682
57	Rear Wheel & Tire Assembly (Not Shown)	10004033

### 12V 18Ah AGM Battery for NewRider 1700

These are high performance sealed 12 Volt 18 Amp Hour AGM Batteries available at most auto parts stores or online. The battery dimensions are: 6-7/8" Long x 3-7/16" Wide x 6-1/8" Tall.

Some manufacturer part numbers for this battery:

Interstate Batteries P/N FAYTX20H

NAPA Auto Parts P/N PSB 20BS

O'Reilly Auto Parts P/N GTX20BS

Yuasa P/N YTX20-BS

PowerSonic P/N PTX20-BS

SigmatTek P/N STX20-BS

**\*IMPORTANT NOTE:**

As you look at the side of the battery with the terminals, the correct orientation is, +/- (Positive Left Side / Negative Right Side)

**\*IMPORTANT NOTE: THE BATTERY PART NUMBER MUST NOT HAVE THE LETTER "L" IN IT\***

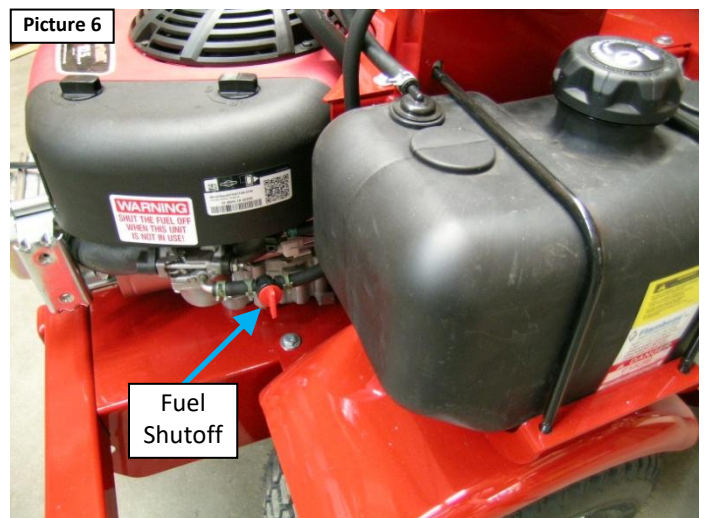
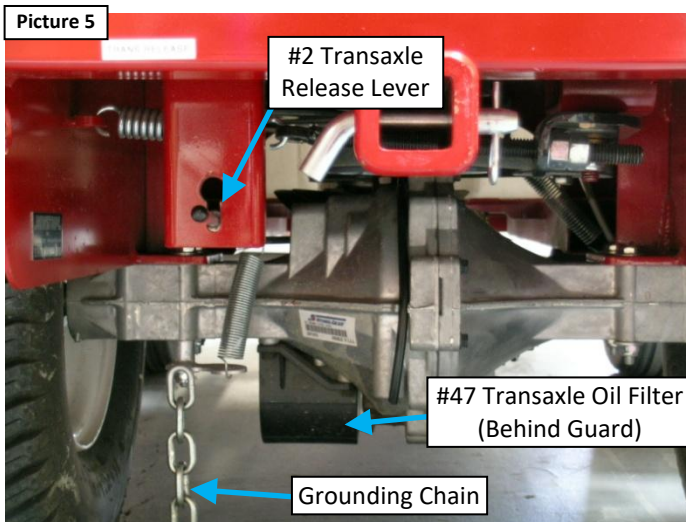

# NewRider™ 1700 Airless Riding Field Line Striper

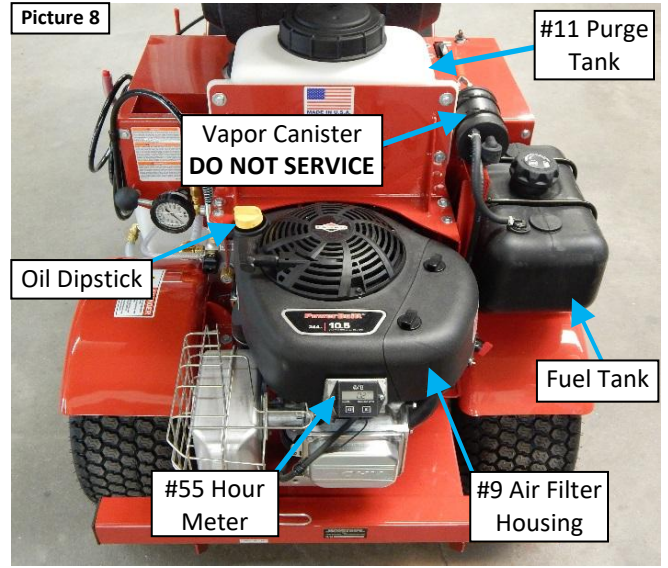
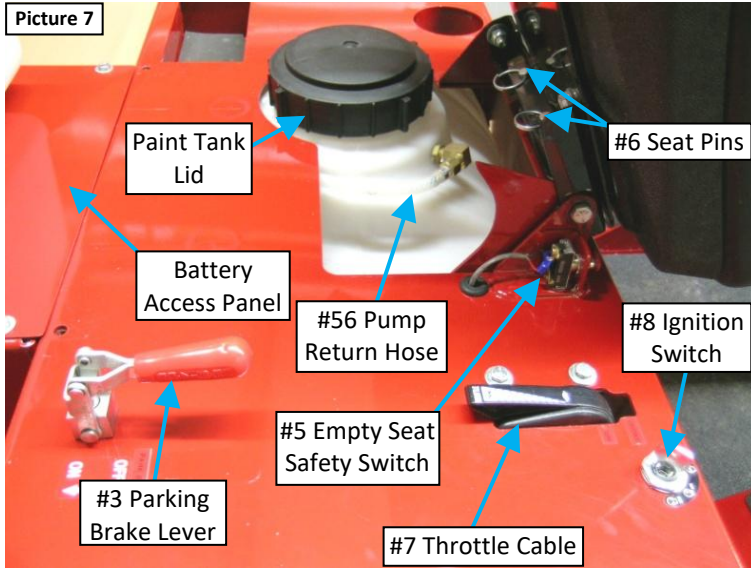

## SPRAY HEAD MOUNTING

## GUN MOUNTING

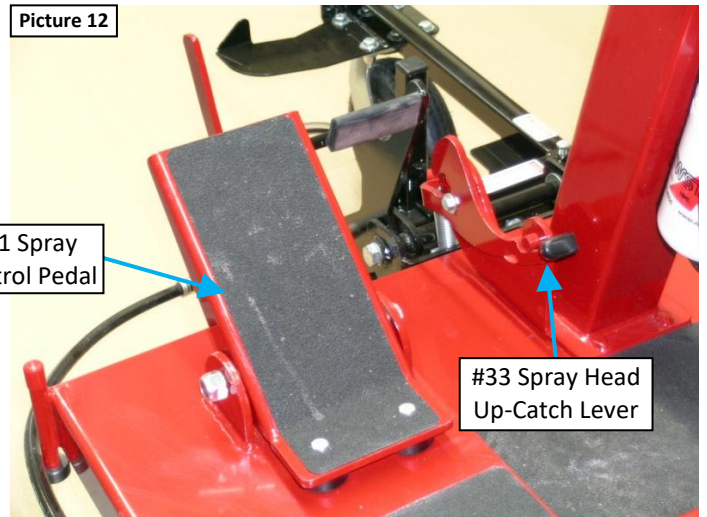
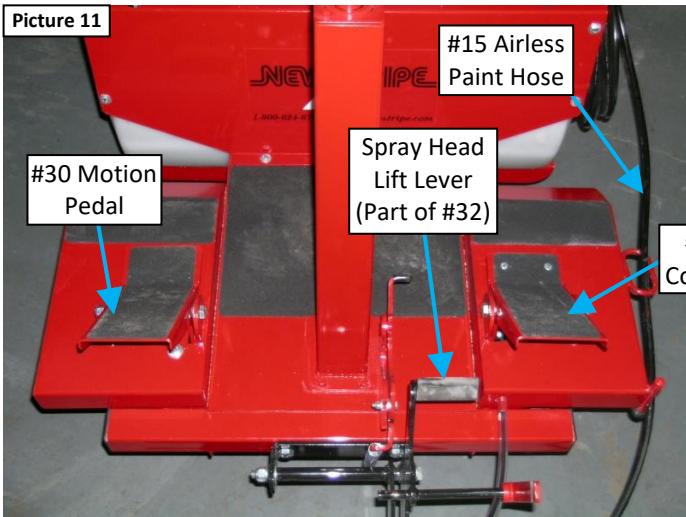
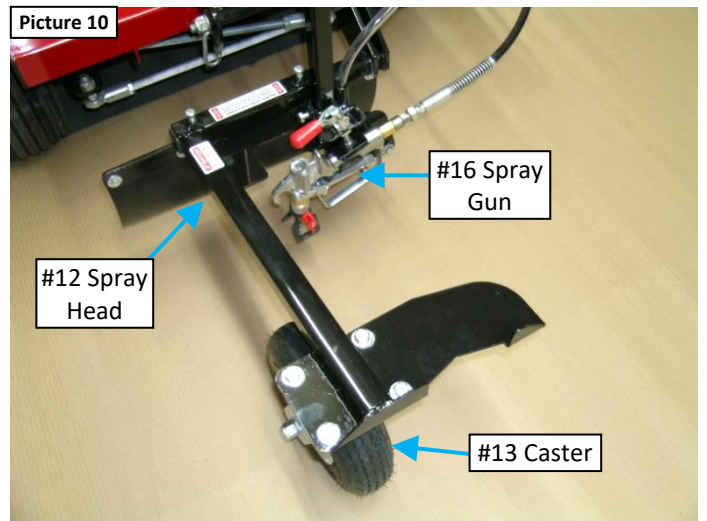
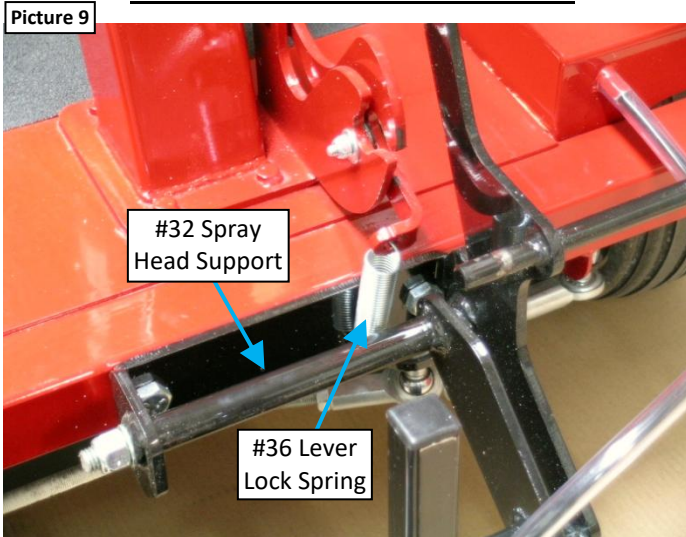

# NewRider™ 1700 Airless Riding Field Line Striper

## VALVES IN TANK FEED POSITION

Picture 13

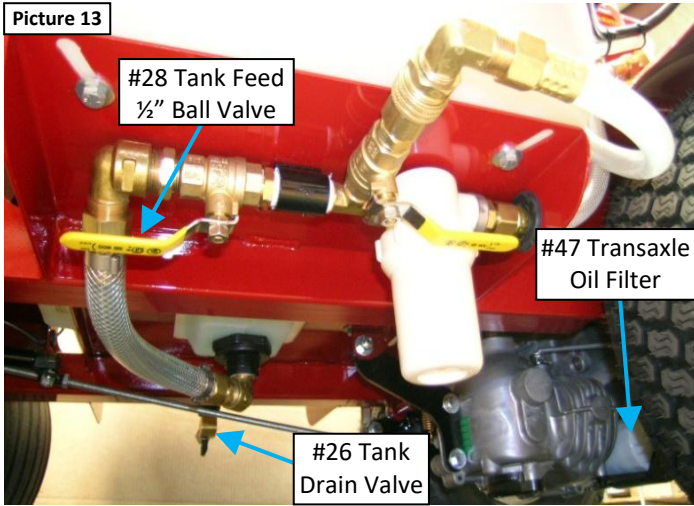

## VALVES IN PURGE POSITION

Picture 14

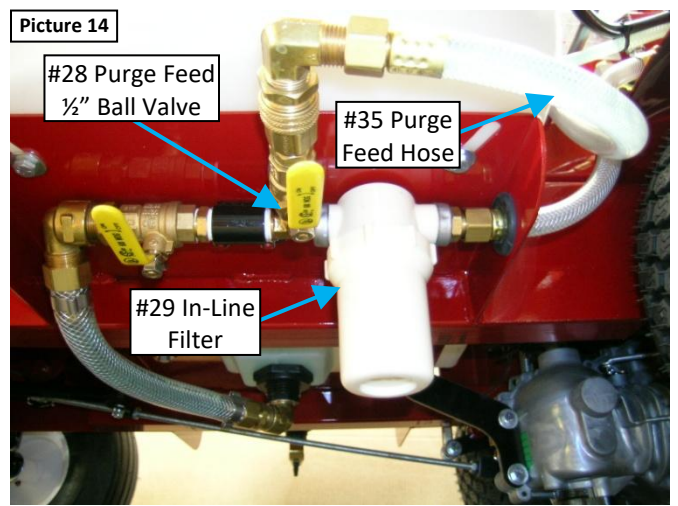

Picture 15

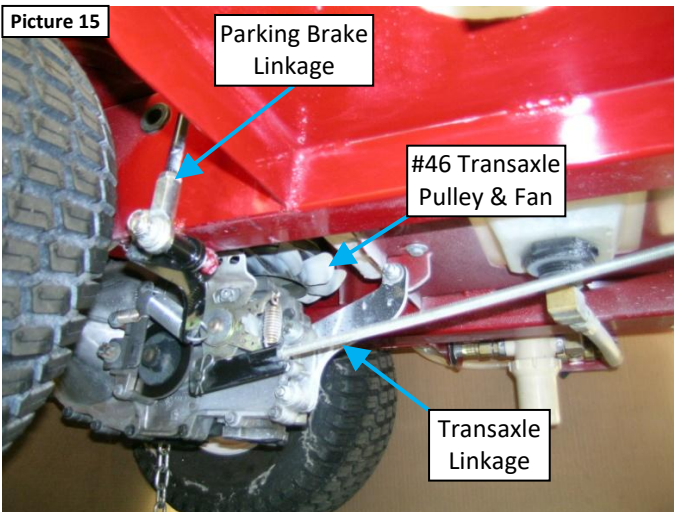

Picture 16

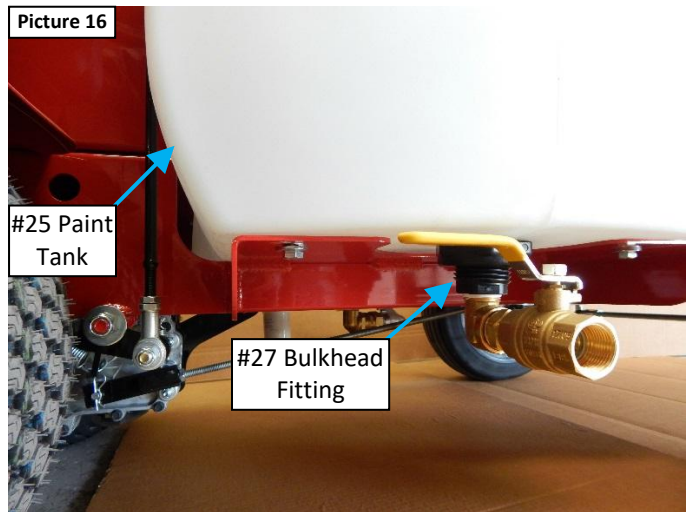

Picture 17

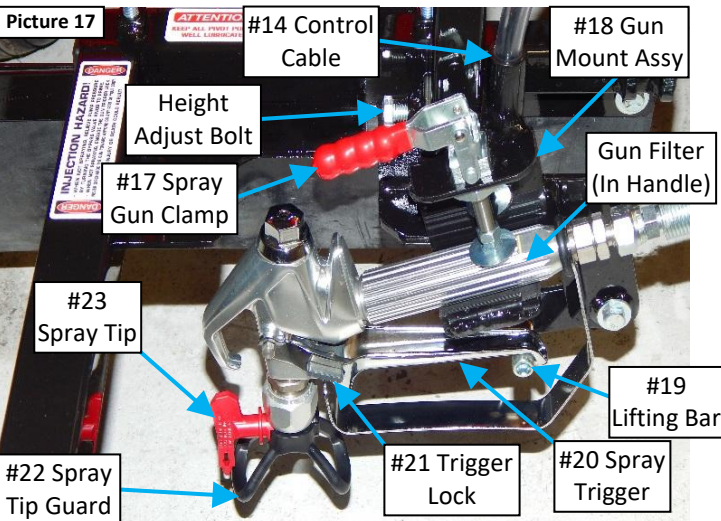

Picture 18

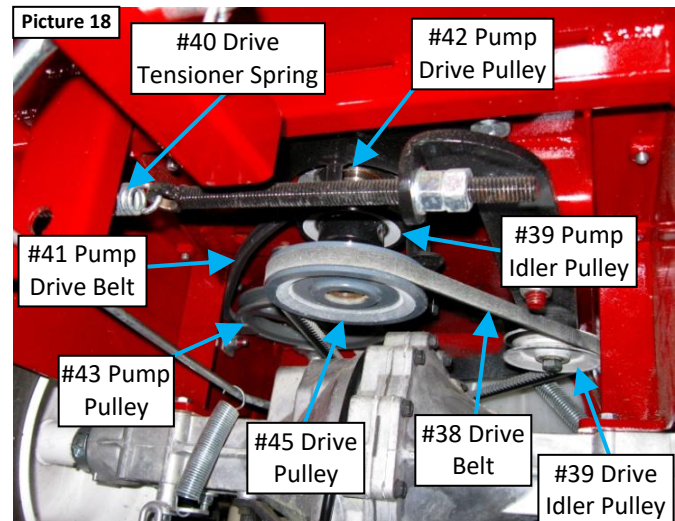

# NewRider™ 1700 Airless Riding Field Line Striper

## AIRLESS PUMP PARTS

Item Number	Description	Part Number
56	Return/Bypass Hose	10004040
57	Spray Pump	10005238
58	Pump Inlet Hose	10004042
59	Prime/Spray Valve	10004000

Item Number	Description	Part Number
60	Pressure Control Valve	10000380
61	Gauge, 0-5000 PSI	10003883
62	Outlet Valve/Push Button Kit	10005102
63	Inlet Valve	10002745

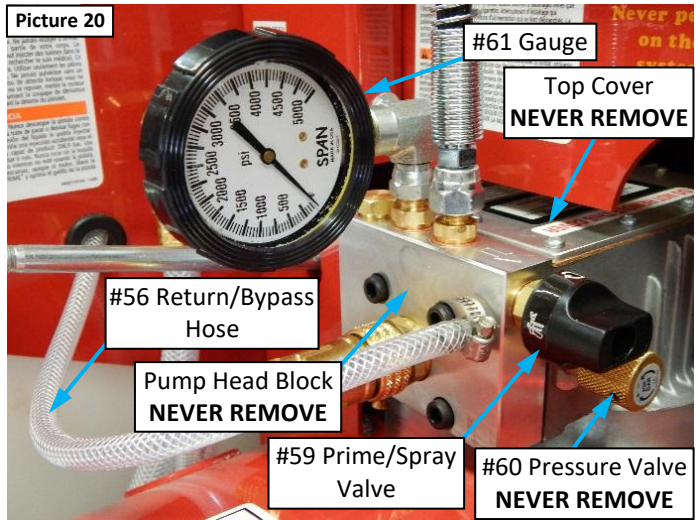
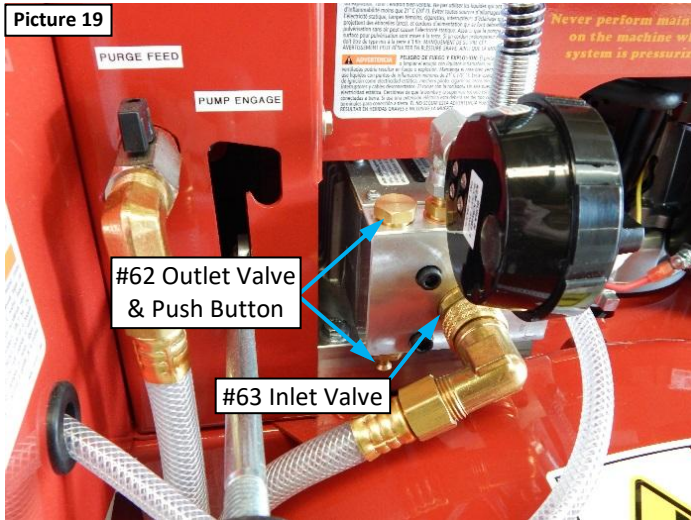

**NEVER REMOVE FRONT COVER, PRESSURE CONTROL VALVE OR THE PUMP HEAD BLOCK.**

**THIS WILL VOID THE WARRANTY.**

**PLEASE CALL THE NEWSTRIPER FOR SERVICE LOCATIONS IF THESE ITEMS REQUIRE SERVICE.**

ITEM	CHECK	REPLACE
Outlet Push Button	Before each use	Replace the Outlet Valve/Push Button Kit every 500-1000 gallons, or if leaking occurs.
Inlet Valve	If the pump does not prime, check the inlet hose washer.	Replace the Inlet Valve every 500-1000 gallons. Replace hose washer every 50-250 gallons.
Outlet Valve	If the pump does not prime	Replace the Outlet Valve/Push Button Kit every 500-1000 gallons.
Prime/Spray Valve	At the beginning of each use	Every 1000-1500 gallons or if it stops working
Return/Bypass Hose	Before each use	Check for nicks and cuts
Spray Pump	Before and after each use	Use Newstripe Pump Defender every time you store the machine. (10000459)
Pump Inlet Hose	Before each use	Replace the hose if it is nicked or has cuts.
Spray Hose	Before each use	Replace the hose if it is nicked or has cuts.

**\*Interval ranges vary due to the wide variety of paint manufacturers.**

# NewRider™ 1700 Airless Riding Field Line Striper

## AIRLESS SPRAY GUN DETAIL

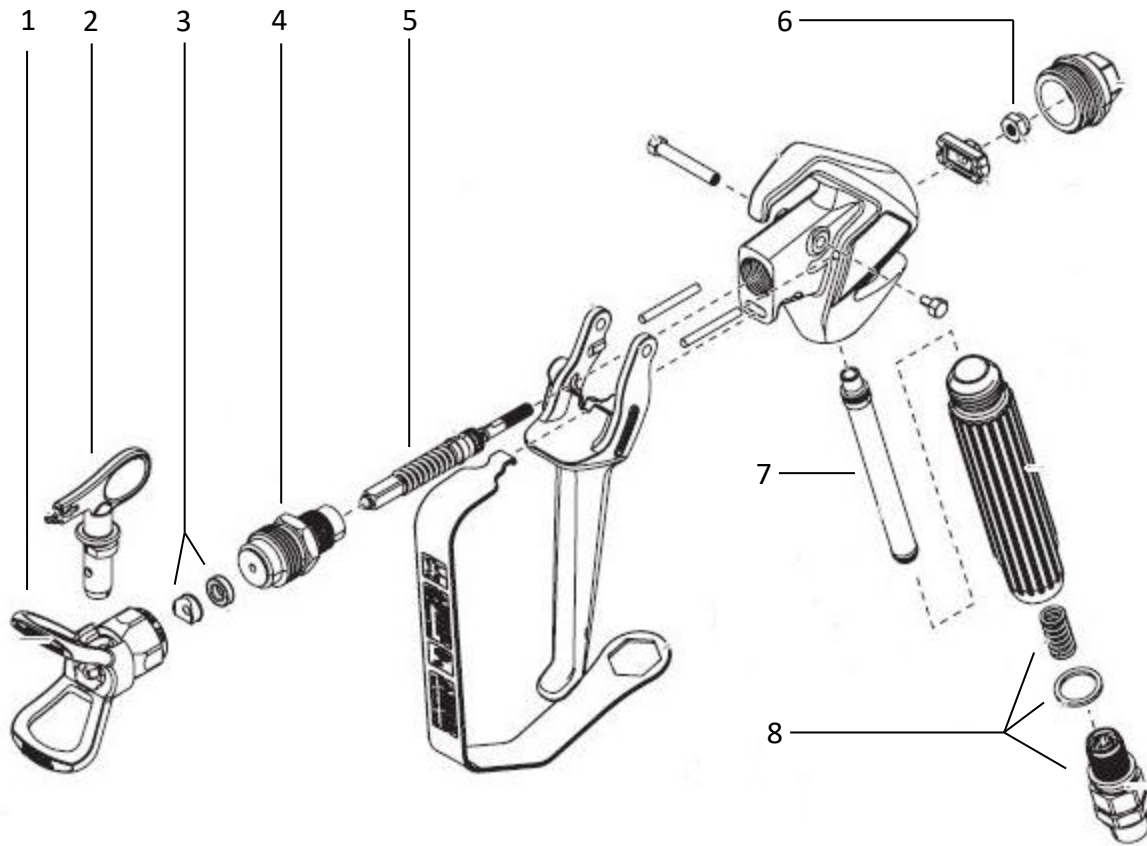

#	Part Number	Description
1	10005116	SPRAY TIP GUARD
2	10002103	319 SPRAY TIP - STANDARD FOR GPS AND SKID MOUNTED STRIPERS
	10005230	419 WHITE SPRAY TIP – UP TO 4" WIDE LINES
	10005151	619 WHITE SPRAY TIP - STANDARD TIP FOR RIDE ON STRIPERS
	10005232	621 WHITE SPRAY TIP - ALLOWS FOR HEAVIER PAINTED LINES
3	10005119	TIP SEAL KIT, PACKAGE OF 5
4	SEE # 9	7/8" DIFFUSER
5	SEE # 9	SEAL NEEDLE ASSEMBLY
6	SEE # 9	LOCK NUT
7	10000641	50 MESH GUN FILTER - STANDARD FILTER FOR STRIPERS
	10004384	OPTIONAL 30 MESH COARSE GUN FILTER
8	10005135	SWIVEL FITTING KIT
9	10005117	AIRLESS SPRAY GUN REPAIR (Includes Item Numbers 4, 5, and 6)

# NewRider™ 1700 Airless Riding Field Line Striper

## TRANSAXLE SERVICE & MAINTENANCE

### Fluid Change

This transaxle is designed with an external filter for ease of maintenance. To ensure constant fluid quality levels and longer life, an initial oil and filter change at 75 hours, then every 400 hours thereafter is recommended.

The following procedure can be performed with the transaxle installed in the vehicle, and the vehicle on level ground. Apply the bypass valve and lock the vehicle parking brake.

1. Remove the three 1/4" filter guard screws and filter guard. Clean any loose debris from around the perimeter of the filter. See filter and filter guard removal Page 15 of this manual.
2. Place an oil drain pan (12" or more diameter and 8 qt. capacity is optimal) beneath the oil filter. Remove the oil filter from the transaxle.
3. After the oil has drained, wipe the filter base surface off and apply a film of new oil to the gasket of the new replacement filter (**Newstripe part number 10003778/Hydro-Gear part number 52114**).
4. Install the new filter by hand, turn 3/4 to one full turn after the filter gasket contacts the filter base surface.
5. Re-install the filter guard with three 1/4" screws. Snug but do not over tighten.
6. Drain old oil filters of all free-flowing oil prior to disposal. Place used oil in appropriate containers and deliver to an approved recycling collection facility.
7. Remove the oil level check port plug from the transaxle prior to filling with oil. This will allow the transaxle to vent during oil fill. Transaxle may be filled via port with a squeeze bottle or a jug pump.
9. Fill with **Mobil 1 Full Synthetic 15W50 Motor Oil\*\*** until oil just appears at the bottom of the oil level check port. Install the oil level check port plug into transaxle. Snug but do not over tighten.
11. Proceed to the purge procedure.
12. Check oil level. Top off if necessary.

**Warning:** Use ONLY Mobil 1 Full Synthetic 15W50 Motor Oil and Newstripe Filter Part Number 10003778 in the transaxle of this machine. Failure to use the correct filter and oil will cause damage to the transaxle and void the warranty.

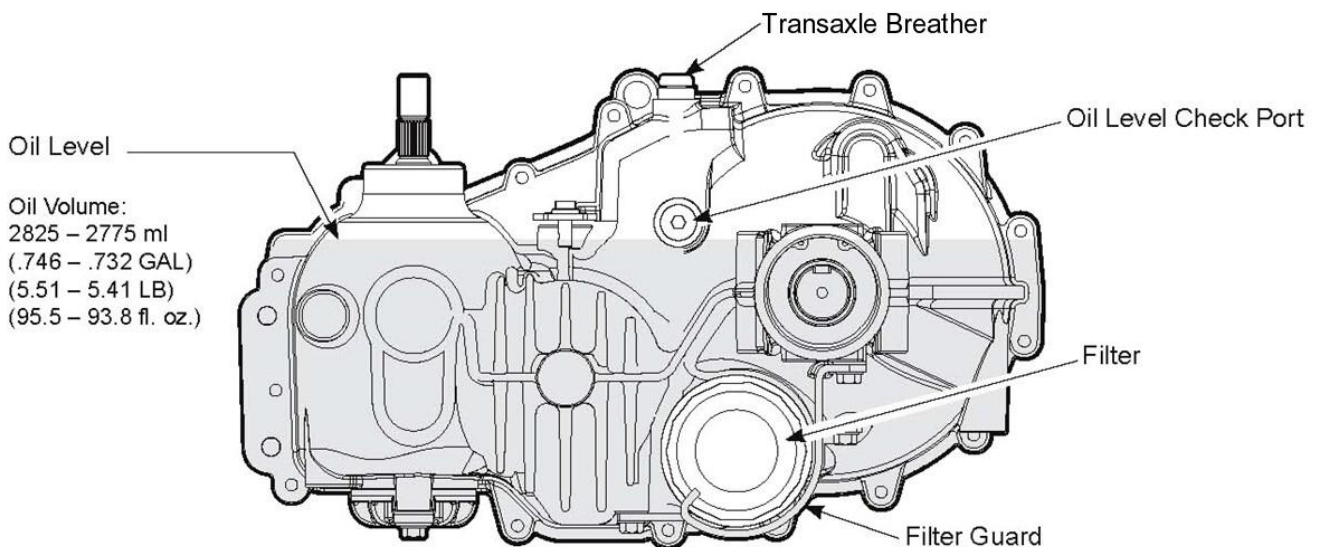

# **NewRider™ 1700 Airless Riding Field Line Striper**

## **TRANSAXLE SERVICE AND MAINTENANCE**

### **External Maintenance**

1. Check the oil level at oil level check port if performance is off or transaxle is noisy.
2. Inspect the vehicle drive belt, idler pulleys, and idler springs. Ensure that no belt slippage can occur. Slippage can cause low input speed to the transaxle.
3. Inspect the vehicle control linkage to the directional control arm on the transaxle. Also ensure that the control arm is securely fastened to the trunnion arm of the transaxle.
4. Inspect the bypass mechanism on the transaxle and the vehicle linkage to ensure that both actuate and release fully.

### **Purging**

Due to the effects air has on efficiency in hydrostatic drive applications, it is critical that it is purged from the system.

Air creates inefficiency because its compression and expansion rate is higher than that of the oil approved for use in hydrostatic drive systems. These purge procedures should be implemented any time a hydrostatic system has been opened to facilitate maintenance, or the oil has been changed. The resulting symptoms in hydrostatic systems may be:

1. Noisy operation.
2. Lack of power or drive after short term operation.
3. High operation temperature and excessive expansion of oil. Before starting, make sure the transaxle is at the proper oil level. If it is not, fill to the specifications outlined in this manual.

### **Purging Procedures**

The following procedures are best performed with the vehicle drive wheels off the ground. Then repeated under normal operating conditions. If this is not possible, then the procedure should be performed in an open area free of any objects or bystanders.

1. Disengage the brake if activated.
2. With the bypass valve open and the engine running, slowly move the directional control in both forward and reverse directions (5 or 6 times).
3. With the bypass valve closed and the engine running, slowly move the directional control in both forward and reverse directions (5 to 6 times). Check the oil level and add oil as required after stopping the engine.
4. It may be necessary to repeat Steps 2 and 3 until all the air is completely purged from the system. When the transaxle operates at normal noise levels and moves smoothly forward and reverse at normal speeds, then the transaxle is considered purged.

**Please call Newstripe at 303-364-7786 if you have any questions.**

# NewRider™ 1700 Airless Riding Field Line Striper

## TROUBLESHOOTING GUIDE

PROBLEM	REMEDY
Engine will not turn over	Check that the battery is connected and charged. Operator out of seat and brake not set.
Engine turns over but will not start	Check that there is fuel in the tank and the fuel valve is open. Make sure the throttle lever is in the full forward (choke) position.
Engine will still not start	Call Newstripe for assistance.
Engine starts, but runs rough	Check that the choke is turned off (throttle back from full forward position)
Choke off but still runs rough	Check for proper fuel. Check the spark plug for fouling. If fouled clean or replace it. Check the air filter. Clean or replace the filter if it is dirty.
Machine will not move when pedal is pressed	Check that the transaxle release lever is in the engaged position. Pull lever up, back, and down to lock.
Machine will still not move	Check that the hand brake is released. Note: If you changed transaxle oil, you will need to purge the system. See Transaxle Fluid Change Procedure
Machine will still not move	Call Newstripe for assistance.
Pump will not prime (No fluid returning to the tank)	Check that the pump engaging lever is in the ON position
Lever engaged, but pump will not prime	Check that the prime/spray valve is in the prime position (Circular arrows aligned with the arrow on the pump housing)
Prime/spray valve in prime position, still will not prime	Check that the pressure valve is in the high-pressure position (valve turned clockwise all the way). Do not overtighten!
Valves are set correct, still will not prime	Push the outlet push button 3 times. (brass button)
Outlet button pushed, still will not prime	Turn the prime/spray valve knob to the prime position. Back out the pressure valve (counterclockwise several turns until loose) and let the pump run for one minute. Then the turn pressure valve knob all the way in. Do not over tighten!
Valves are set correct, button pushed, still will not prime NOTE: A loose inlet fitting, worn or missing rubber washer on the inlet hose is the #1 reason for the pump failing to prime.	Remove the garden hose fitting from the inlet side (bottom) of the pump. Depress the inlet valve stem so it moves freely. Reconnect the inlet hose. MAKE SURE the inlet hose fitting is tight, and the rubber washer is present. Restart the engine & prime as described above.
Pump primes and is running, but the gun does not spray	Check that the prime/spray valve is in the spray position. Check that the pressure control valve knob is turned in fully clockwise to the high-pressure setting. (Clockwise until it stops) <b>Do not force!</b> Press the brass outlet push button three times.
Pump will still not prime	Call Newstripe for assistance.
Valves are set correctly, still does not spray	Check that the trigger lock on the spray gun is pushed to the spray position. Check that the spray tip arrow is pointing towards the ground. Check that the lifting bar is operating the gun trigger.

# NewRider™ 1700 Airless Riding Field Line Striper

## TROUBLESHOOTING GUIDE (CONTINUED)

PROBLEM	REMEDY
All of the above are correct, gun will still not spray	Turn prime/spray valve to the prime position and turn off the engine. Pull the gun trigger to release pressure. Check spray gun filter and replace it if it is clogged.
Gun will still not spray paint	Call Newstripe for assistance
Overspray or too much paint	Lower the spray pressure. Turn the pressure valve counterclockwise several turns and then increase the pressure just until the spray pattern is full width.
Too little paint	Increase the spray pressure. The paint may need to be thinned. Change the spray tip to a larger size.
Uneven spray pattern or stringing	Increase the spray pressure. The spray tip may be chipped or clogged. Reverse the tip and trigger the spray gun to clear the tip.
Pressure increased, tip is clean, spray still not correct	The spray tip is worn. (sprayed more than 100 gallons) Replace the tip.
Replaced tip, spray is still not correct	Call Newstripe for assistance

Your machine is designed to be simple and safe to operate.  
**Please call Newstripe at 303-364-7786** if you have any questions.

# **NewRider™ 1700 Airless Riding Field Line Striper**

## **U.S. EPA, AND NEWSTRIPE, INC. EVAPORATIVE EMISSION CONTROL WARRANTY STATEMENT**

### **YOUR WARRANTY RIGHTS AND OBLIGATIONS FOR MACHINES NOT FOR SALE IN CALIFORNIA**

Newstripe, Inc. is pleased to explain the evaporative emission control system's warranty on your 2026 small off-road line painter engine. New equipment that use small off-road engines must be designed, built, and equipped to meet stringent anti-smog standards. Newstripe, Inc. must warrant the evaporative emission control system on your small off-road line painter engine for the period listed below provided there has been no abuse, neglect or improper maintenance of your equipment leading to the failure of the evaporative emission control system.

Your evaporative emission control system may include parts such as: carburetors, fuel tanks, fuel lines (for liquid fuel and fuel vapors), fuel caps, valves, canisters, filters, clamps, connectors, and other associated components.

#### **MANUFACTURER'S WARRANTY COVERAGE:**

This evaporative emission control system is warranted for two years. If any evaporative emission related part on your equipment is defective, the part will be repaired or replaced by Newstripe, Inc.

#### **OWNER'S WARRANTY RESPONSIBILITIES:**

- As the small off-road engine line painter owner, you are responsible for performance of the required maintenance listed in your owner's manual. Newstripe, Inc. recommends that you retain all receipts covering maintenance on your line painter, but Newstripe, Inc. cannot deny warranty coverage solely for the lack of receipts.
- As the small off-road engine line painter owner, you should be aware that Newstripe, Inc. may deny you warranty coverage if your line painter or a part has failed due to abuse, neglect, or improper maintenance or unapproved modifications.
- You are responsible for presenting your line painter to a Newstripe, Inc. distribution center or service center as soon as the problem exists. The warranty repairs shall be completed in a reasonable amount of time, not to exceed 30 days. If you have a question regarding your warranty coverage, you should contact Newstripe at 303-364-7786.

#### **DEFECTS WARRANTY REQUIREMENTS:**

- (a) The warranty period begins on the date the engine or equipment is delivered to the ultimate purchaser.
- (b) General Evaporative Emissions Warranty Coverage. The fuel tank must be warranted to the ultimate purchaser and any subsequent owner that the evaporative emission control system when installed was:
  - (1) Designed, built, and equipped so as to conform with all applicable regulations; and
  - (2) Free from defects in materials and workmanship that causes the failure of a warranted part for a period of two years.
- (c) The warranty on evaporative emissions-related parts will be interpreted as follows: (1) Any warranted part that is not scheduled for replacement as required maintenance in the written instructions must be warranted for the warranty period defined in subsection (b)(2). If any such part fails during the period of warranty coverage, it must be repaired or replaced by Newstripe, Inc. Any such part repaired or replaced under the warranty must be warranted for a time not less than the remaining warranty period.

## **NewRider™ 1700 Airless Riding Field Line Striper**

(2) Any warranted part that is scheduled only for regular inspection in the written instructions must be warranted for the warranty period defined in subsection (b) (2). A statement in such written instructions to the effect of “repair or replace as necessary” will not reduce the period of warranty coverage. Any such part repaired or replaced under warranty must be warranted for a time not less than the remaining warranty period.

(3) Any warranted part that is scheduled for replacement as required maintenance in the written instructions must be warranted for the period of time prior to the first scheduled replacement point for that part. If the part fails prior to the first scheduled replacement, the part must be repaired or replaced by Newstripe, Inc. Any such part repaired or replaced under warranty must be warranted for a time not less than the remainder of the period prior to the first scheduled replacement point for the part.

(4) Repair or replacement of any warranted part under the warranty provisions of this article must be performed at no charge to the owner at a warranty station.

(5) Notwithstanding the provisions of subsection (4) above, warranty services or repairs must be provided at distribution centers that are franchised to service the subject engines or equipment.

(6) The owner must not be charged for diagnostic labor that leads to the determination that a warranted part is in fact defective, provided that such diagnostic work is performed at a warranty station.

(7) Throughout the evaporative emission control system's warranty period set out in subsection (b) (2), Newstripe, Inc. must maintain a supply of warranted parts sufficient to meet the expected demand for such parts.

(8) Manufacturer approved replacement parts must be used in the performance of any warranty maintenance or repairs and must be provided without charge to the owner. Such use will not reduce the warranty obligations of the manufacturer issuing the warranty.

(9) The use of any add-on or modified parts will be grounds for disallowing a warranty claim made in accordance with this article. The manufacturer issuing the warranty will not be liable under this Article to warrant failures of warranted parts caused by the use of an add-on or modified part.

(10) Newstripe, Inc. shall provide any documents that describe the warranty procedures or policies within five working days of request.

### EMISSION WARRANTY PARTS LIST:

- 1) Fuel Tank, cap, and tether
- 2) Fuel line, fuel line fittings, and clamps
- 3) Carbon Canister
- 4) Vapor hoses

# **NewRider™ 1700 Airless Riding Field Line Striper**

**10004026**

## **36 Month Warranty**

Newstripe, Inc. (“Newstripe”) warrants to the original purchaser, for 36 (Thirty-Six) Months after date of purchase, that the equipment\* hereby sold shall be free of defects in materials and workmanship. This warranty does not extend to any damage or malfunction resulting in misuse, neglect, accident, improper operation, or normal wear and tear.

\* Gasoline engines, compressors, low pressure pumps, and transaxles are furnished with their respective manufacturers' warranties only and are not covered by any warranty of Newstripe. High pressure pumps manufactured by Newstripe (excluding wear items like diaphragms and valves) are warranted for materials and workmanship for 12 Months after the date of purchase.

Damage incurred in shipment from Newstripe to the purchaser is the total responsibility of the shipping carrier. The purchaser is responsible for noting any damages on the Bill of Lading of the shipping carrier and Newstripe will work with the shipping carrier to resolve any damages incurred.

The Newstripe obligation under this warranty and any implied warranties is limited to replacement or repair of defective parts of its manufacture without charge for 36 (Thirty-Six) Months from date of purchase. For service under this warranty, the purchaser shall obtain an approved Return Materials Authorization (RMA) from Newstripe and then ship the defective part or parts of the equipment, transportation prepaid by the purchaser, to Newstripe together with a written description of any claimed defect and proof of purchase date of the materials being returned. To review Newstripe’s complete guidelines for warranty claims and returns, please visit our website at [www.newstripe.com](http://www.newstripe.com).

The responsibilities described above are the only responsibilities of Newstripe under this written warranty or any implied warranty and may be exercised only within 36 (Thirty-Six) Months from the date of original purchase. In no event shall Newstripe be liable for incidental or consequential damages and no person had any authority to bind it to any representation or warranty. Newstripe is not responsible for work done, materials furnished, or repairs made by others without its specific written authorization.

This warranty shall be in lieu of any and all other warranties, expressed or implied, including any warranties of merchantability or fitness for a particular purpose, and there is no other representation or warranty of any kind with respect to the goods sold hereby except as set forth herein. It is expressly agreed that this warranty shall be limited to the adjustment, repair or replacement of parts and the labor and services required thereby. In no event, including any claim of negligence, shall Newstripe be liable for incidental or consequential damages.



**[newstripe.com](http://newstripe.com) / 303-364-7786**